

PostMount 1-A for XL Panel

Code-Compliant Planning and Installation Guide V 2.0
Complying with AS/NZS 1170.2: 2021



Introduction

Clenergy PVezRack® PostMount 1-A for XL Panel (up to 2100 x 1100 mm) is a ground mounting system suitable for large scale commercial and utility scale installations. PVezRack® PostMount 1-A for XL Panel has been developed to fit any PV module in the outdoors and uneven ground areas. PVezRack® PostMount 1-A for XL Panel have good compatibility for the different region via the angle adjustment (10°~60°). Using high quality engineered components PostMount 1-A for XL Panel saves developers and installers, time and money when delivering large scale projects.

Please review this manual thoroughly before installing PostMount 1-A for XL Panel. This manual provides the following contents:

- 1) Installation planning;
- 2) Installation instructions.

The PVezRack® PostMount 1-A for XL Panel parts, when installed in accordance with this guide, will be structurally adequate and meet the AS/NZS 1170.2: 2021 standard. During installation, and especially when working on the ground, please comply with the appropriate occupational health and safety regulations. Please also pay attention to other relevant regulations in your local region. Please check that you are using the latest version of the installation manual by contacting Clenergy via email on www.clenergy.com.au or contacting your local distributor.

Product Warranty:

Please refer [PVezRack® Product Warranty](#) on our website.

List of contents





Introduction	01
Tools & Components	02
System Overview	03 - 05
Installation Instruction	06 - 07
Certification	08 - 12

The installer is solely responsible for:





- Complying with all applicable local or national building codes, including any updates that may supersede this manual;
- Ensuring that PVezRack® and other products are appropriate for the particular installation and the installation environment;
- Using only PVezRack® parts and installer supplied parts as specified by PV-ezRack® project plan (substitution of parts may void the warranty and invalidate the letter of certification);
- Recycling: Recycle: according to the local relative statute;
- Ensuring that there are no less than two professionals working on panel installation;
- Ensuring the installation of related electrical equipment is performed by licenced electricians;
- Ensuring safe installation of all electrical aspects of the PV array, including providing adequate earth bonding of the PV array and PV-ezRack® PostMount components as required in AS/NZS 5033: 2021.

Tools and Components

Tools

			
<p>Allen Key 6 mm</p>	<p>Spanner</p>	<p>Torque Wrench</p>	<p>5m Tape</p>

Components

			
<p>C-U/30/46-G Universal Clampx4</p>	<p>ER-AP-PM1/A-LP PostMount 1-A Kitx1</p>	<p>ER-P-83/2400 Polex1</p>	<p>EZ-GL-ST/UC Grounding Lugx2</p>

System Overview

1. PostMount 1-A for XL Panel



1. PostMount 1-A Kit 2. Pole 3. Universal Clamp

Side view drawing of PV-ezRack® PostMount 1-A for XL Panel is shown below. The panels tilt angle and embedment depth below are for reference only. Please refer to Certificate Letter to obtain the certified max panels tilt angle and min embedment depth for different wind regions and different soil types.

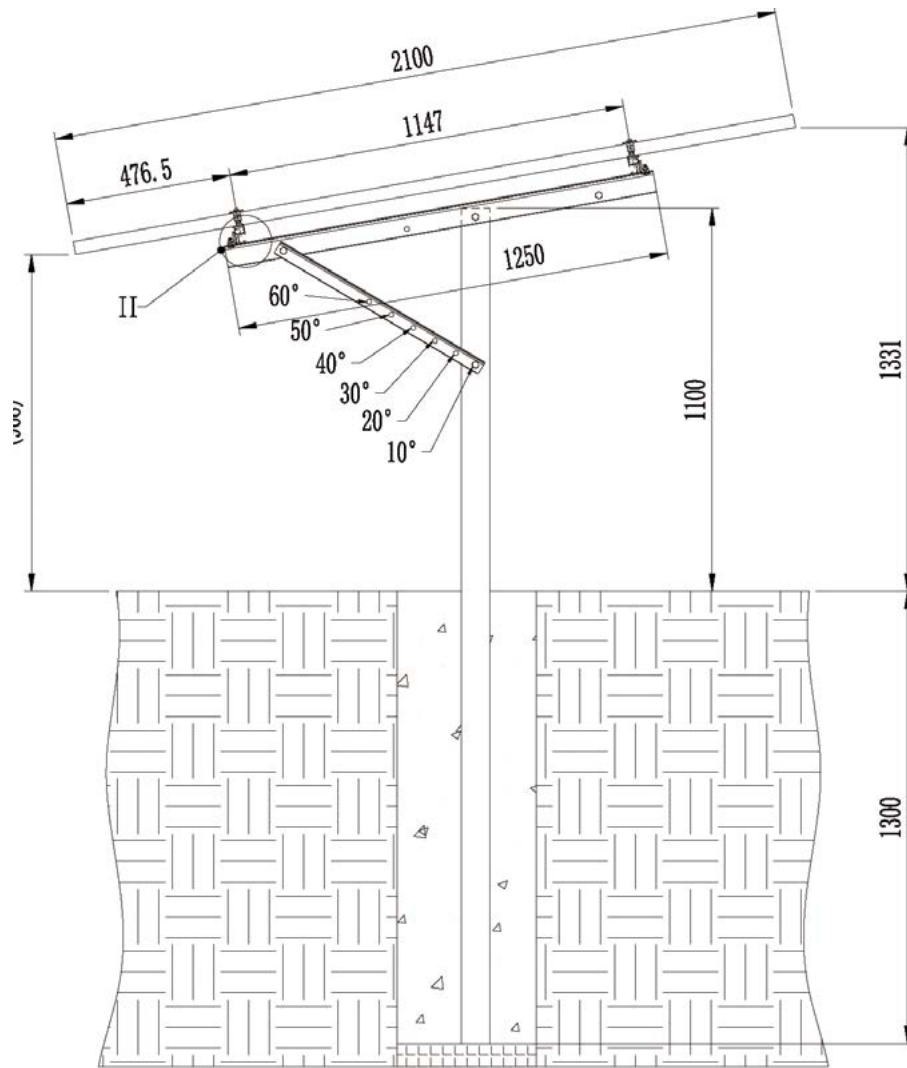

2. Precautionary Measures for Stainless-Steel Fastener Installation

Improper operation may lead to the deadlock of bolts and nuts. Follow the steps below to reduce this risk.

Reduce the friction coefficient

- (1) Ensure that the thread surface is clean (no dirt or contaminant).
- (2) Apply lubricant (grease or 40# engine oil) to fasteners prior to tightening to avoid galling or seizing in the threads.

General installation instructions

- (1) Apply force to fasteners in the direction of thread.
- (2) Apply force uniformly to maintain required torque.
- (3) Professional tools and tool belts are recommended.
- (4) Avoid using electric tools for final tightening.
- (5) Avoid working at high temperatures.

Safe Torques

Please refer to safe torques defined in this guide as shown in the figure below. If power tools are required, Clenergy recommends the use of low speed only. High speed and impact drivers increase the risk of bolt galling (deadlock). If deadlock occurs and you need to cut fasteners, please make sure that there is no load on the fastener before you cut it. Avoid damaging the anodized or galvanized surfaces.

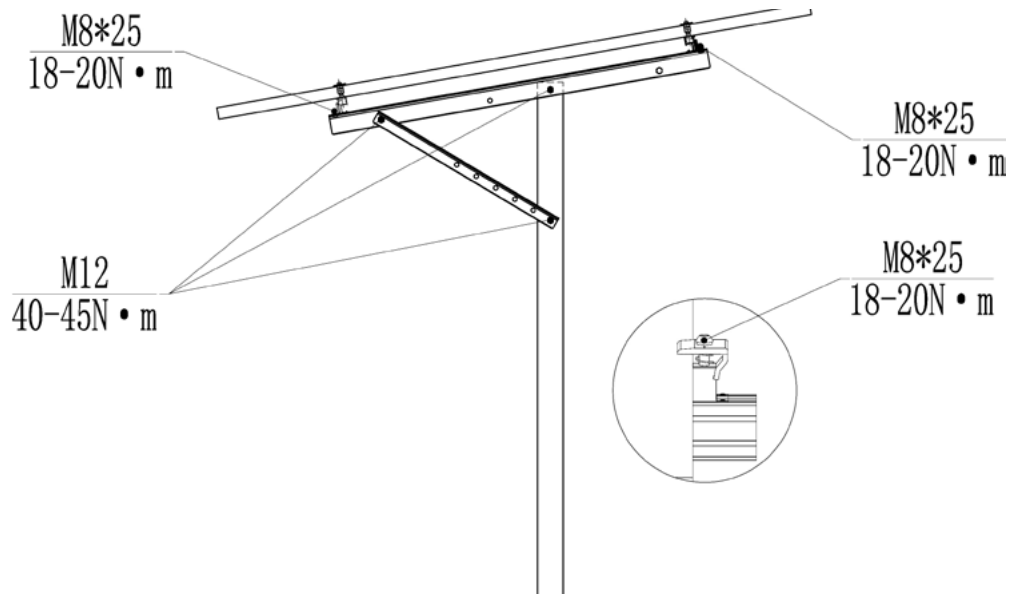

3. Installation Dimensions

All drawings and dimensions in this installation guide are for generic reference. The PV-ezRack® PostMount 1-A for XL Panel is to be optimized to suit specific conditions for each project and documented in engineering drawings. As a result, major components of the PV-ezRack® PostMount 1-A for XL Panel may be provided in sectional sizes and lengths that vary from those shown in this guide. The installation operations detailed in this instruction guide remain the same regardless of the component size. In case you need to do any on-site modifications or alteration of the system in a way that would be different from engineering drawings, please provide marked up drawings/sketches for Clenergy’s review prior to modification for comment and approval.

Installation Instruction

1. Pole 83*2400 Installation

Dig a hole with the diameter of 300mm.

Place the pole into the middle of the hole and fill it with concrete. Maintain the position of the post. The allowed vertical tolerance is $\pm 2^\circ$. Keep the axle of the 2- $\varnothing 14$ holes parallel to East-West; keep the vertical angle deviation within $\pm 5^\circ$. For more than one system on one site maintain all the axles of 2- $\varnothing 14$ holes aligned.

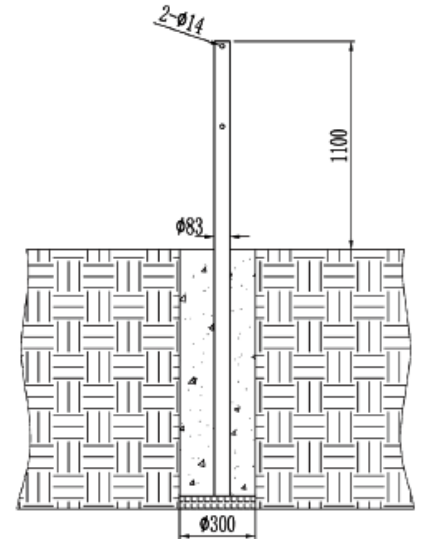

2. PostMount 1-A Kit Installation

1) As show in figure on the right, with M12 * 120 hex bolts and nuts to lock Angle Steel 63*40*1250 on the Pole. And then use M12 * 120 hex bolts and nuts to lock supporting rod 40 * 40 * 682 on the Pole.

Note:
supporting rod around multiple holes which can be adjusted by adjusting the mounting, adjustable angle of 10°, 20°, 30°, 40°, 50° and 60°.

Recommended torque for M12 bolts is 40~45 N·m



2) As show in figure on the right, place the ECO-Rail on Angle Steel. Use the Cross Connection Clamp, Cup head square neck bolts M8*25, Hexagon nut with flange M8 to lock on the Angle Steel 63 * 40 * 1010

Recommended torque for M8 bolts is 18~20 N·m

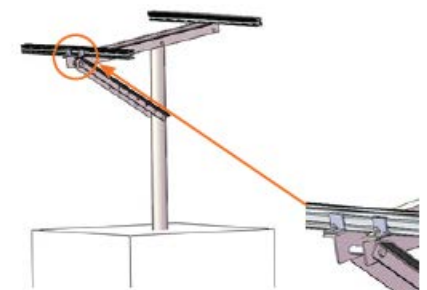

3) Position the PV Panel landscape by aligning the centre line with the ECO-Rail. And fix the PV Panel to the Rails by using Universal Clamps.

Recommended torque for M8 bolts is 18~20 N·m

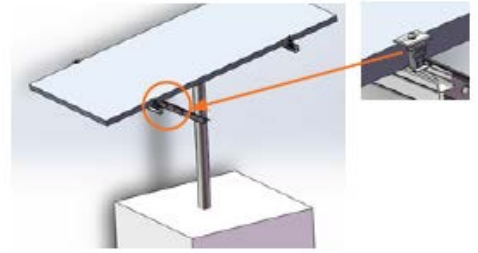

There are three solutions for Grounding Lug installation.

Solution 1:

Fix the Grounding Lug at the end of Rail as shown in the figure on the right.



Solution 2:

Fix the Grounding Lug at the Rail where just under the PV Module as shown in the figure on the right.

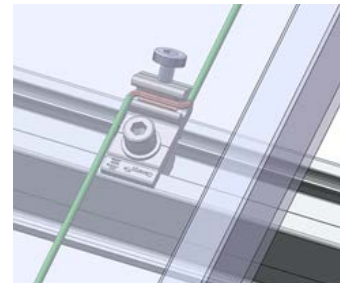

Solution 3:

Fix the Grounding Lug at the side channel of Rail as shown in the figure on the right.

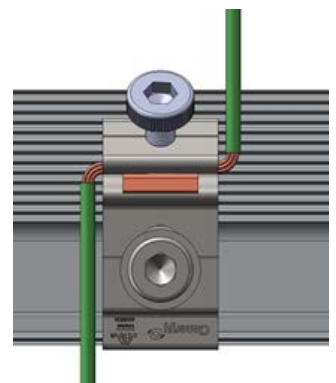

Certification



REF: CL-126-S-REV1
Internal REF: 00139

11 April 2022

Client: **Clenergy Australia**
1/10 Duerdin Street
Clayton, VIC 3168

Array Frame Engineering Certificate

Postmount PM1-A/XL Installation

MW Engineering Melbourne Pty Ltd, being Structural Engineers within the meaning of Australian and NZ Building Regulations, have carried out a structural design check of the PV-ezRack Postmount PM1-A/XL within Australia. The design check has been based on the information in the *PV-ezRack PM1-A/XL Planning and Installation Guide* and schematic drawings of the system components, provided by Clenergy Australia.

Part Number	Part Number (sub-component)	Item Description
ER-R-ECO/XXXX		PV-ezRack ECO Rail, length XXXX
R-ECO/XXXX/AUMF		PV-ezRack Australian Made Mill Finish ECO Rail, length XXXX
ER-EC-STXX		PV-ezRack End Clamp - Standard XX
ER-AP-PM1A/XL	C-U/30/46-G	PV-ezRack, Universal Clamp for Frame Height 30-46mm with Grounding Clip
	ER-AP-PM1/A-LP	PV-ezRack PostMount 1-A Kit Suitable for Mounting 1 maximum 2100mm long panel
	EZ-GL-ST/UC	PV-ezRack Grounding Lug, with Clenergy Logo, with U-Shape Copper Channel
ER-P-83/2400		PV-ezRack Pole for PostMount 1-A, Ø83x2400mm

We find the Postmount PM1-A/XL to be structurally sufficient for Australian use, based on the following conditions:

- Wind Loads to AS/NZ1170.2:2021:
 - Design life: 25 years
 - Wind Terrain Category: 2;
 - Wind average recurrence interval of 100 years- for ultimate state, 25 years- service-ability;
 - Wind region A, B1, B2, C & D;



REF: CL-126-S-REV1
Internal REF: 00139

- Max Solar Panel Length 2.1m, width 1.1m;
- Panel weight calculated: 25 kg
- Number of rails per panel: 2
- Yield Strength:
 - Steel: 300 MPa,
 - Aluminium: 240 MPa;
- Maximum tilt angle options: refer to tables;
- Dimension as shown here on the picture;

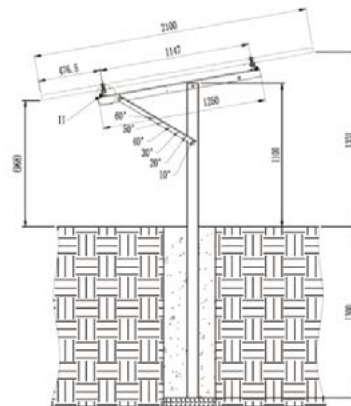
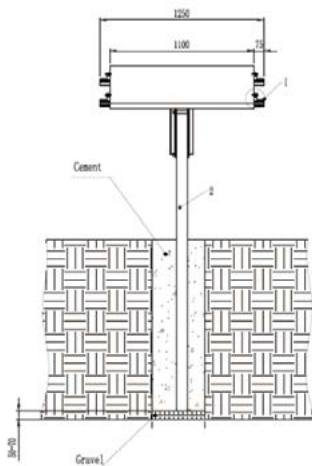



MW Engineering

REF: CL-126-S-REV1
Internal REF: 00139

Maximum Tilt Angle Options:

	Wind Region				
	Region A	Region B1	Region B2	Region C	Region D
Wind regional speed (m/s)	41	48	48	56	66
Maximum tilt angle (°)	60	60	20	20	10
Soil Type	Post Embedded in concrete pier: 300 mm diameter concrete piers minimum depth (m)				
Hard or very dense soil [Gravels; dry (hard) clays]	1.08	1.12	1.17	1.20	1.24
Very Firm or dense soil [Dry (Stiff) clays; clayey sands; coarse sands; compact sands]	1.16	1.15	1.20	1.27	1.30
Firm or medium dense soil [Damp clays; sandy clays; damp sands]	1.33	1.36	1.45	1.50	1.56
Soft or loose soil [wet clays; silty clays and sands; silty loams; wet loose sands]	1.59	1.66	1.74	1.80	1.86

Notes:

1. The assessment is based on the capacity of the fixings and the solar array frame. This document does not include or certify the PV panel; however, both the panel weight and geometry have been considered when designing the array frame.
2. Clamping zone of the PV panels must be according to the manufacturer’s specifications.
3. For Terrain Category (TC) definition, please refer to clause 4.2.1 of AS/NZS 1170.2:2021.
4. Wind Direction Multiplier (Md) taken as 1.0. Refer to clause 3.3 of AS/NZS 1170.2:2021 for more information.
5. Shielding Multiplier (Ms) taken as 1.0. Refer to clause 4.3 of AS/NZS 1170.2:2021 for more information.
6. Topographic Multiplier (Mt) taken as 1.0. Refer to clause 4.4 of AS/NZS 1170.2:2021 for more information.
7. This certificate cannot be used if the site is located on a hill, ridge or escarpment. Contact Clenergy if the aforementioned condition is met on site.
8. No consideration has been taken on the effect of snow loads. In case the roof is located in a snow prone area, a project specific design must be completed.
9. Contact Clenergy if pier diameter requirements is different from 300 mm.
10. Footing depths are for reference only.



REF: CL-126-S-REV1
Internal REF: 00139

11. For concrete pier foundations, use a minimum 25 Mpa concrete compressive strength should be used.
12. According to AS 1726.1993 (Geotechnical site investigations), the soil can be identified as per below table (*)

Soil Type	Soil Parameters			Visual Classification Based on texture	
	Bearing capacity Clays (kPa)	Bearing capacity Sands (kPa)	Field guide	Clay	Sand
Hard or very dense soil [Gravels; dry (hard) clays]	>200	> 300	Can be indented with difficulty by thumb nail	Particles may be described as powdery, can be moulded, playdough texture.	Particles may be described as 'rounded', 'sub-rounded', 'sub-angular', or 'angular'.
Very Firm or dense soil [Dry (Stiff) clays; clayey sands; coarse sands; compact sands]	100-200	300	Can be indented by thumb nail		
Firm or medium dense soil [Damp clays; sandy clays; damp sands]	25-50	150	Can be moulded by strong finger pressure		
Soft or loose soil [wet clays; silty clays and sands; silty loams; wet loose sands]	> 12 - 25	< 50	Can be moulded by light finger pressure		

(*) the above table is only for guidance and it must not be taken for final installations.

13. This certificate cannot be used if the following is present on the soil:
 - a. **Organic matter** such as: Fibrous peat, charcoal, wood fragments, root and root fibres.
 - b. **Waste fill** such as: Domestic refuse, oil, bitumen, brickbats, concrete rubble, fibrous plaster, wood pieces, wood shavings, sawdust, iron filings, drums, steel bars, steel scrap, bottles, broken glass and leather.
14. We highly recommend to check the characteristics of the soil on site by a geotechnical expert. Clenergy must be informed on the outcome of the soil report.
15. The following soil and/or terrain conditions are not covered on this engineering certificate and we highly recommend to carry out a soil test report if you find the below conditions on site.
 - a. Unstable slopes
 - b. Soil with visible poor drainage



MW Engineering

REF: CL-126-S-REV1
Internal REF: 00139

- c. Uncontrolled fill
 - d. Areas close to a river/creek
 - e. Undulating, hilly, or mountainous terrains
16. The installation of the ER-R-ECO rail splice is not allowed when installing PM1-A/XL.
17. System is suitable for installation up to ISO corrosivity category C4.
18. From the date of publication onwards, any amendment made to any of the above-mentioned Standards will make this report outdated and a new one will have to be released, unless the amendment has no implications on this certificate.
19. All components from Clenergy must be installed according to manufacturer's specification and the instructions shown in the relevant installation manual. Please check the Clenergy Australia website or contact them for access to the most recent installation manuals.

Should you have any queries, do not hesitate to contact us.

Best Regards,



Alberto Escobar
Civil/Structural Engineer
BEng MIEAust NER
PE 0003615
RPEQ 18759
BDC 3134
BPB (NT) 262228ES
BSP (TAS) 845530344
info@mwengineering.melbourne







PV-ezRACK®

Clenergy

1/10 Duerdin St
Clayton VIC 3168
Australia

Phone: +61 3 9239 8088
Email: sales@clenergy.com.au
Web: www.clenergy.com.au

 @ClenergyGlobal / @ClenergyClub / ClenergyAUS  @Clenergy  @ClenergyClub
 @Clenergy_global  @Clenergy

A Clenergy Technologies Company